

4 MODULE ENCLOSURES

700 High/Low

SERIES
M4

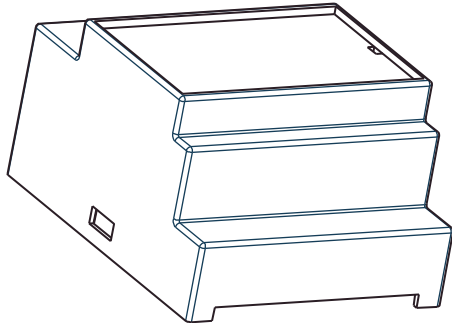

Module enclosure for M36 Din-rail. Series High-Low is, if requested with custom made holes for connectors and terminals. Lid, PCB, customized label and packing is available. Possibility for both base and top PCB. A closed version without terminals is also available. Trimmers and spindles that fit the height of the box are available.

SECTION A-A

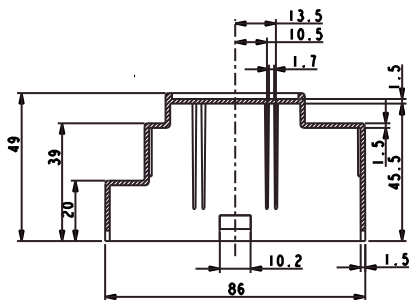

SECTION B-B

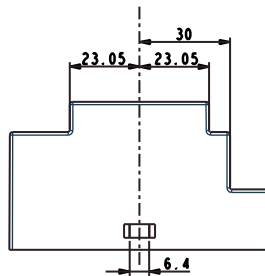
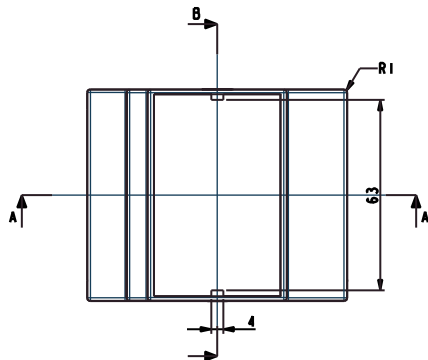
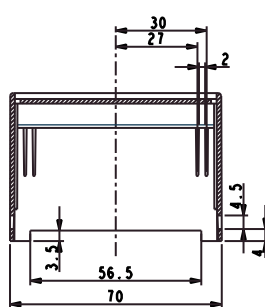

TECHNICAL DATA:

TOP PART:

Material: Lexan 940
 Colour: Grey (RAL 7035)
 Max. temperature: 100°C
 Width: 70 mm
 (4 modules)
 Label measurement: 41.0 x 66.0 mm
 Self-extinguishing: Acc. to UL94-V0
 IP Protection: IP 20

BASE PART:

Material: Noryl VO 1550
 Colour: Black (RAL 9005)
 Max. temperature: 100°C
 Max. load: 16 A (for higher load please enquire)
 Terminals: 24 fixed or plugable
 Mounting: DIN-rail (EN50022)
 Self-extinguishing: Acc. to UL94-V0

HORIZONTAL PCB DIMENSIONS:

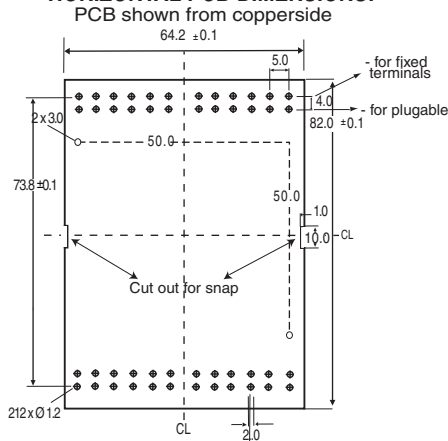

TYPE 700 High/low M4:	ORDER CODE
Complete, 257 for plugable	p/n 4979340702
Complete, 605 for fixed terminals	p/n 4979340701
Complete, closed, no terminals	p/n 4979340700
Top part, 257, plugable	p/n 4979330702
Top part, 605 / 250 fixed terminals	p/n 4979330701
Top part, grey, closed, no terminals	p/n 4979330700
Base part with clip and 2 screws	p/n 4969002701
DIN-rail clip for 700	p/n 0669000604
Transparent lid for 700	p/n 4969001700
Packing for 700	p/n 2068700001
Raw PCB for 700	p/n 4999000700
Terminal for 700, 257/12, HO/A, PCB part	p/n 1155712580
Terminal for 700, 256/12, wire part	p/n 1155612080
Terminal for 700, 605/12, fixed terminals	p/n 3950141208
Screw/selfcutting 2 pcs.	p/n 7006102965

- All measurements are in mm.
- Please note that most plugable terminals are in 5,08 pitch and need a bigger hole in the PCB